

Болт М20×80 ГОСТ 7798-70

Гайка М20 ГОСТ 5915-70

Шайба 20 ГОСТ 11371-78

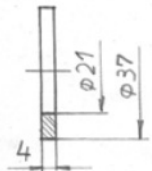
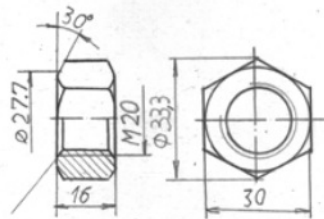
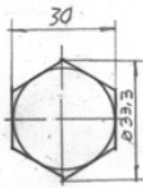
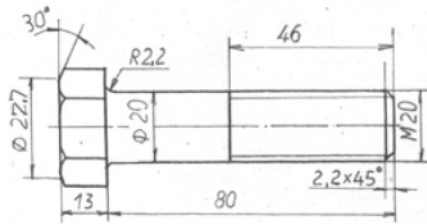

Болтовое соединение

Шпилька М20×80 ГОСТ 22032-76

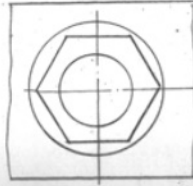
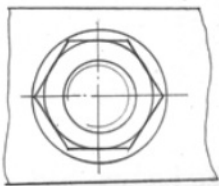
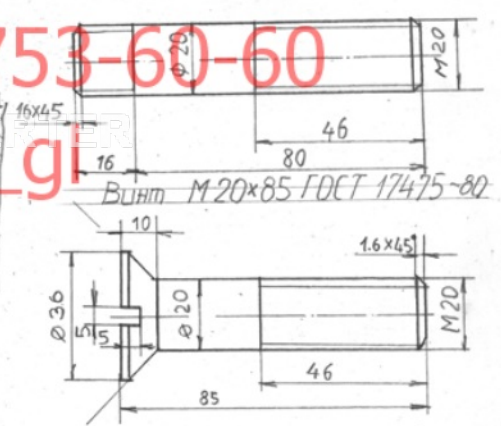
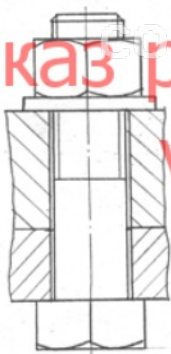
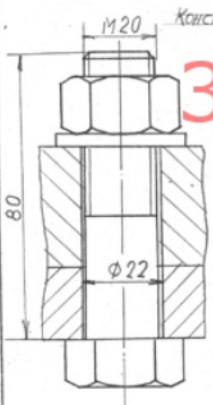

Вариант № 8

Крепежные изделия

1/1

Заказ работ 8 920 753-60-60
vk.com/tuigu_gi